

This guide provides basic installation information for specific UniStream® PLC models with built-in I/O. Technical specifications may be downloaded from the Unitronics website.

### General Features

Unitronics' UniStream® PLCs are DIN-rail mounted Programmable Logic Controllers (PLCs) with a built-in I/O configuration.

The series is available in three versions: Pro, Standard, and Basic.

Note that a model number that includes:

- **B10/C10** refers to Pro version (e.g. USC-B10-T24)
- **B5/C5** refers to Standard version (e.g. USC-B5-RA28)
- **B3/C3** refers to Basic version (e.g. only for USC-B3-T20)

Page 2 contains a comparison table detailing the features offered by the different models. Exact features are detailed in the product specification sheets.

---

<b>Power Features</b>	<ul style="list-style-type: none"><li>▪ Built-in Trends and Gauges, auto-tuned PID, data tables, data sampling, and Recipes</li><li>▪ UniApps™: Access &amp; edit data, monitor, troubleshoot &amp; debug and more</li><li>▪ Security: Multi-level password protection</li><li>▪ Alarms: Built-in system, ANSI/ISA standards</li></ul>
-----------------------	--

---

<b>COM Options</b>	<ul style="list-style-type: none"><li>▪ Built-in ports: 2 Ethernet, 1 USB host, 1 USB device port</li><li>▪ Add-on ports (UAC-CB), available by separate order:<ul style="list-style-type: none"><li>➢ 1 CANbus port may be added to all models</li><li>➢ RS232/485 ports: according to model technical specifications</li></ul></li></ul>
--------------------	--

---

<b>COM Protocols</b>	<ul style="list-style-type: none"><li>▪ Fieldbus: CANopen, CAN Layer2, MODBUS, EtherNetIP and more. Implement any serial RS232/485, TCP/IP, or CANbus third-party protocols via Message Composer</li><li>▪ Advanced: SNMP Agent/Trap, e-mail, SMS, modems, GPRS/GSM, FTP Server/Client, Web Server, SQL, and MQTT.</li><li>▪ Remote Access via any device that supports VNC.</li></ul>
----------------------	--

---

<b>Programming Software</b>	All-in-One UniLogic software for hardware configuration, communications, PLC and HMI applications; free download.
-----------------------------	---

---

<b>HMI</b>	All UniStream® PLCs can display HMI screens on the following devices: <ul style="list-style-type: none"><li>• UniStream Display (USL)</li><li>• UniStream Modular HMI panel (USP)</li><li>• UniStream Built-in (on the panels integral to the device)</li><li>• Any device screen that supports VNC</li></ul>
------------	---

---

<b>HMI</b>	<p>HMI screens are designed in UniLogic. In addition to the HMI screens, UniStream® PLCs offer built-in HMI features, including:</p> <ul style="list-style-type: none"> <li>• UniApps™: Access &amp; edit data, monitor, troubleshoot, debug, and more</li> <li>• Security: Multi-level password protection</li> <li>• Alarms: Built-in system, ANSI/ISA standards</li> </ul>
------------	---

<b>USB Action files</b>	<p>Programmers can create files in UniLogic and save them to a USB mass storage device, such as a flash drive. This enables the end user to implement certain actions such as to update firmware, update network settings, download applications, extract log files and more.</p>
-------------------------	---

<b>Comparison table</b>	<b>Feature</b>	<b>B10/C10 Pro</b>	<b>B5/C5 Standard</b>	<b>B3/C3 Basic</b>
	I/O Expansion via Uni-I/O	Yes		No
	Remote I/O Expansion via Ethernet I/O Adapter (URB)	Up to 8		1
	VFD	32		2
	MicroSD	Yes		No*
	Add-on COM modules	3		2
	System Memory	6GB	3GB	3GB
	MODBUS Slaves	Unlimited		Up to 8
	Ethernet/IP Scanners	16		1
	Ethernet/IP Adapters	32		8
	Web Server	Yes	No	No
	SQL Client	Yes	No	No
	MQTT	Yes		
	PID Loops	64		2
	Data Sampler/Trends	Yes		No
	CSV files: creating/reading	Yes		No
	FTP, server/client	Yes		No
	Saving Data Tables to SD	Yes		No*
	Screenshots	Yes		No
	Sending email attachments	Yes		No
	USB device (programming port)	Yes		No**

\* Note that B3/C3 models do not support features requiring SD cards. In addition, Alarm History is not retained after PLC reset.

\*\* Note that B3/C3 models may be programmed only via Ethernet cable.



## Before You Begin

Before installing the device, the user must:

- Read and understand this document.
- Verify the Kit Contents.

## Alert Symbols and General Restrictions

When any of the following symbols appear, read the associated information carefully.

<i>Symbol</i>	<i>Meaning</i>	<i>Description</i>
	<i>Danger</i>	<i>The identified danger causes physical and property damage.</i>
	<i>Warning</i>	<i>The identified danger could cause physical and property damage.</i>
<i>Caution</i>	<i>Caution</i>	<i>Use caution.</i>

- All examples and diagrams are intended to aid understanding, and do not guarantee operation. Unitronics accepts no responsibility for actual use of this product based on these examples.
- Please dispose of this product according to local and national standards and regulations.
- This product should be installed only by qualified personnel.

- 
  - Failure to comply with appropriate safety guidelines can cause severe injury or property damage.
  - Do not attempt to use this device with parameters that exceed permissible levels.
  - Do not connect/disconnect the device when power is on.

## Environmental Considerations

- 
  - Ventilation: 10mm space is required between the device top/bottom edges and the enclosure's walls
  - Do not install in areas with: excessive or conductive dust, corrosive or flammable gas, moisture or rain, excessive heat, regular impact shocks or excessive vibration, in accordance with the standards and limitations given in the product's technical specification sheet.
  - Do not place in water or let water leak onto the unit.
  - Do not allow debris to fall inside the unit during installation.
  - Install at maximum distance from high-voltage cables and power equipment.

**Kit Contents**

- 1 UniStream PLC
- 1 power terminal block
- 3 I/O terminal blocks (provided only with models comprising built-in I/Os)
- 1 Battery

**Product Diagram**

1	Output LEDs	Green / Red LEDs
2	Status LEDs	Tricolor LEDs, Green/Red/Orange From top to bottom: RUN, ERROR, USB, BATT. LOW, and FORCE.  Note that LED indications are listed in the product's technical specifications.
3	DIN-rail clips	Clips at top and bottom physically support the device
4	Input LEDs	Green / Red LEDs
5	Top Door, Closed	Covers the Confirm button and the USB Host port
6	Bottom Door, Closed	Covers the internal door protecting the battery and microSD slot.

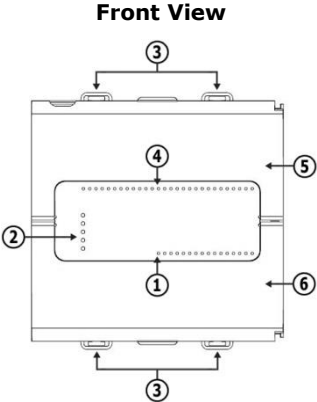

7	Uni-COM™ Jack	Connection port for Uni-COM CB modules*. Shipped covered; leave cover in place when not in use.
8	Ethernet ports	Two ports for Ethernet communications.
9	Input/Output connection points	Model-dependent. Present in models with built-in I/O configurations.
10	I/O Bus connector	(Not shown) Connection point for Uni-I/O™ modules and I/O expansion adapters, shipped covered. Leave covered when not in use.
11	CONFIRM Button	Used to implement and confirm USB Actions.
12	USB Host port	Provides the interface for external USB devices.

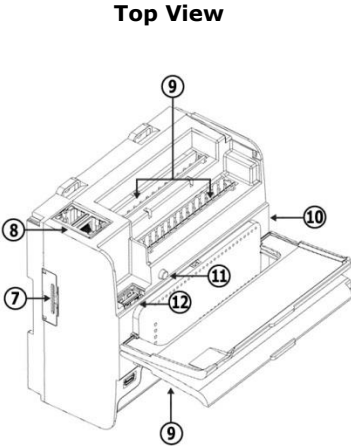

13	Internal Door, open	Open this to access the battery + microSD slot.
14	Power Supply Input	Connection point for the controller power source. Connect the Terminal Block supplied with the kit to the power cable.
15	USB Device port	Use for application download and direct PC-UniStream communication.
16	microSD Slot	Supports standard microSD cards.
17	Battery Holder	The battery is supplied installed; the user must remove the pull tab during installation.

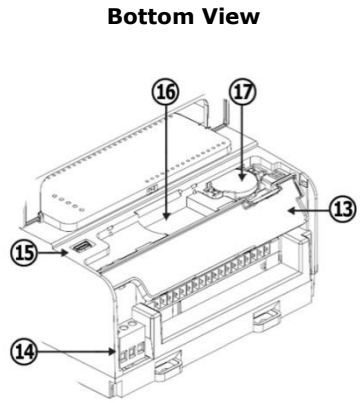

\* These are available by separate order.

### Installation Space Considerations

Allocate space for:

- The controller
- I/O wiring
- Access to ports, jacks, and the microSD card slot
- Any modules that will be installed; ensure you allow space to install/uninstall modules  
Module dimensions and installation instructions are in the modules' specifications.

For exact dimensions, please refer to the Mechanical Dimensions shown below.

### Mechanical Dimensions

**Front View**

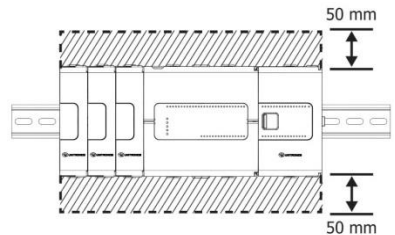
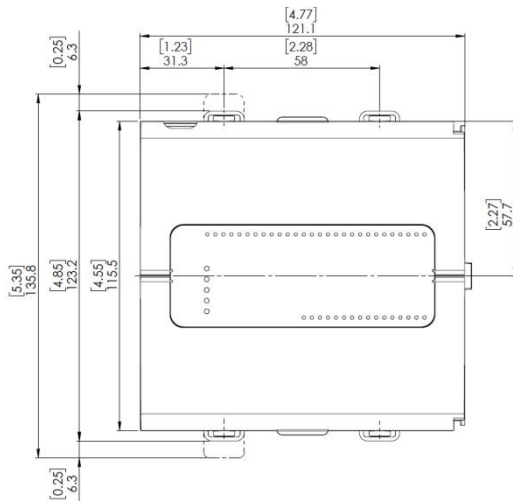

**Bottom View**

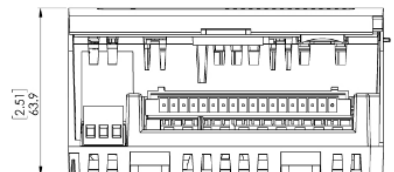

**Mounting**

- Note
- Mount on a standard DIN-rail.
  - Ensure that there is sufficient room on the sides of the device to allow for any I/O or COM modules.

1. Push the device onto the DIN-rail until the clips located at the top and bottom of the unit have snapped onto the DIN-rail.
2. When properly mounted, the device is squarely situated on the DIN-rail as shown below.

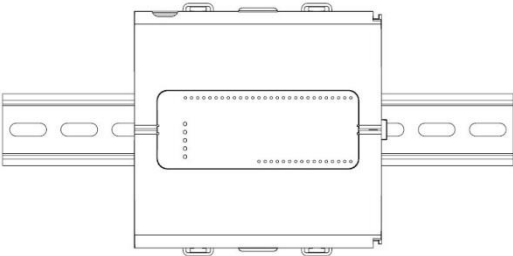

**Battery: Back-up, First Use, Installation, and Replacement**

**Back-up**

In order to preserve back-up values for RTC and system data in the event of power off, the battery must be connected.

**First Use**

The battery is protected by the PLC's bottom and inner door.

The battery is supplied installed inside the unit, with a plastic tab preventing contact. Pull out this tab before using the device.

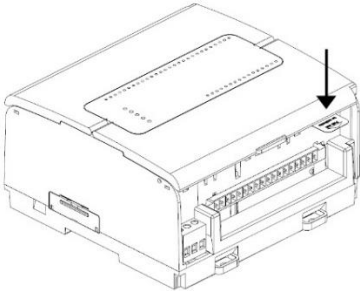

**Battery Installation and Replacement**

- ⚠ Use proper precautions to prevent Electro-Static Discharge (ESD) while servicing the battery.

- Caution*
- To preserve back-up values for RTC and system data during battery replacement, the controller must be powered.
  - Note that disconnecting the battery halts the preservation of back-up values and causes them to be deleted.

1. Open the bottom and inner doors.
2. If there is a battery present, remove it.
3. Slide the battery into place.

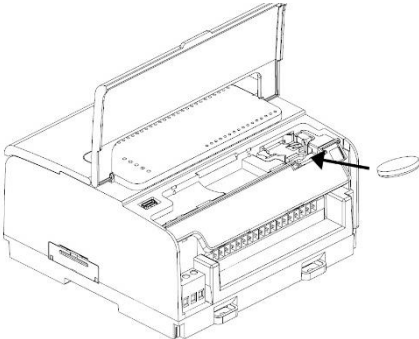

## microSD Card Installation and Removal

---

- ⚠️ ▪ Use proper precautions to prevent Electro-Static Discharge (ESD) while servicing the microSD card.
- 

1. To install the microSD card slide it into the slot as shown in the accompanying figure, until the card clicks into place.
2. To remove the card, press it into its slot lightly, the spring ejects it.

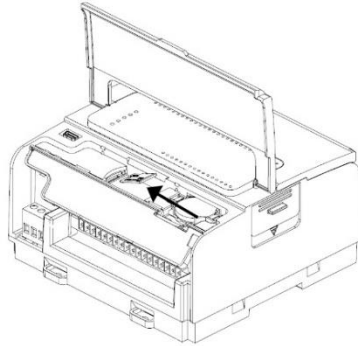

## Wiring

---

- ⚠️ ▪ This equipment is designed to operate only at SELV/PELV/Class 2/Limited Power environments.
- All power supplies in the system must include double insulation. Power supply outputs must be rated as SELV/PELV/Class 2/Limited Power.
  - Do not connect either the 'Neutral' or 'Line' signal of the 110/220VAC to device's 0V point.
  - Do not touch live wires.
  - All wiring activities should be performed while power is OFF.
  - Use over-current protection, such as a fuse or circuit breaker, to avoid excessive currents into the power supply connection point.
  - Unused points should not be connected (unless otherwise specified). Ignoring this directive may damage the device.
  - Double-check all wiring before turning on the power supply.
- 

- Caution* ▪ To avoid damaging the wire, use a maximum torque of 0.5 N·m (4.4 in-lb).
- Do not use tin, solder, or any substance on stripped wire that might cause the wire strand to break.
  - Install at maximum distance from high-voltage cables and power equipment.
- 

## Wiring Procedure

Use crimp terminals for wiring; use 26-12 AWG wire (0.13 mm<sup>2</sup> –3.31 mm<sup>2</sup>)

1. Strip the wire to a length of 7±0.5mm (0.250–0.300 inches).
  2. Unscrew the terminal to its widest position before inserting a wire.
  3. Insert the wire completely into the terminal to ensure a proper connection.
  4. Tighten enough to keep the wire from pulling free.
-

## Wiring Guidelines

In order to ensure that the device will operate properly and to avoid electromagnetic interference:

- Use a metal cabinet. Make sure the cabinet and its doors are properly earthed.
- Use wires that are properly sized for the load.
- Use shielded twisted pair cables for wiring High Speed and Analog I/O signals. Use shielded cables for wiring thermocouple and RTD signals. In either case, do not use the cable shield as a signal common / return path.
- Route each I/O signal with its own dedicated common wire. Connect common wires at their respective common (CM) points at the controller.
- Individually connect each 0V point and each common (CM) point in the system to the power supply 0V terminal, unless otherwise specified.
- Individually connect each functional ground point (⚡) to the earth of the system (preferably to the metal cabinet chassis). Use the shortest and thickest wires possible: less than 1m (3.3') in length, minimum thickness 14 AWG (2 mm<sup>2</sup>).
- Connect the power supply 0V to the earth of the system.
  
- Earthing the cables' shield:
  - Connect the cable shield to the earth of the system (preferably to the metal cabinet chassis). Note that the shield must be connected only at one end of the cable; it is recommended to earth the shield at the PLC-side.
  - Keep shield connections as short as possible.
  - Ensure shield continuity when extending shielded cables.

**NOTE** For detailed information, refer to the document System Wiring Guidelines, located in the Technical Library in the Unित्रonics' website.

## Wiring the Power Supply

The controller requires an external power supply.



- In the event of voltage fluctuations or non-conformity to voltage power supply specifications, connect the device to a regulated power supply.

Connect the +V and 0V terminals as shown in the accompanying figure.

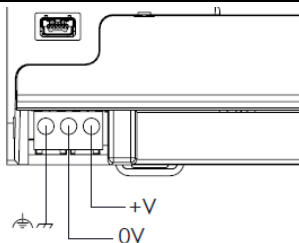

## Connecting Ports

- Ethernet                    CAT-5e shielded cable with RJ45 connector
- USB Device                Use a standard USB cable, Type mini-B
- USB Host                    Standard USB Type-A plug



Note that below, the letters “xx” that is used in the model numbers means that the section refers both to B5/C5 and B10/C10 models.

### I/O Connection Points

The IOs for these models are arranged in three groups of fifteen points each, as shown in the figures to the right.

#### Top groups

Input connection points

#### Bottom group

Output connection points

The function of certain I/Os may be adapted via wiring and software settings.

#### USC-xx-RA28

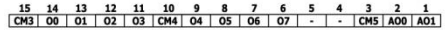
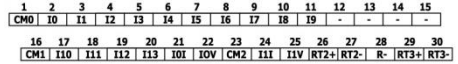

#### USC-xx-TA30

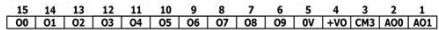
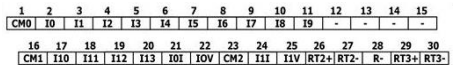

### Wiring the Digital Inputs

The digital inputs are arranged in two isolated groups:

- I0-I9 share common CM0
- I10-I13 share common CM1

Each group may be wired together as sink or source.

Inputs I10, I11, I12 and I13 can be configured as either normal digital inputs or as high speed inputs that can receive high speed pulse signals from sensors or shaft encoders.

### High Speed Input Modes

Following are the different pin assignments for the high speed channels:

	Channel 1		Channel 2	
	I10	I11	I12	I13
<b>Quadrature</b>	Phase A	Phase B	Phase A	Phase B
<b>Pulse+Direction</b>	Pulse	Direction	Pulse	Direction
<b>Pulse</b>	Pulse	Normal digital	Pulse	Normal digital

**NOTE** ▪ Input modes are set both by wiring and software.

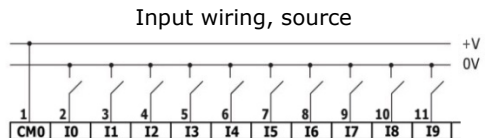
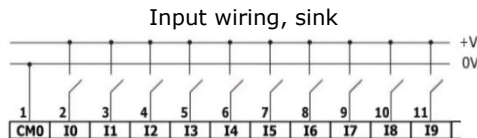

High Speed Input wiring, sink

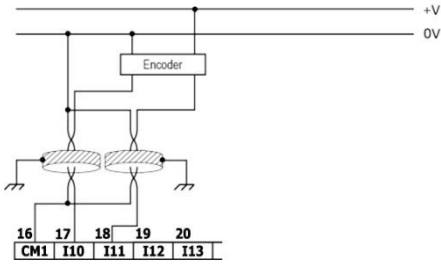

High Speed Input wiring, source

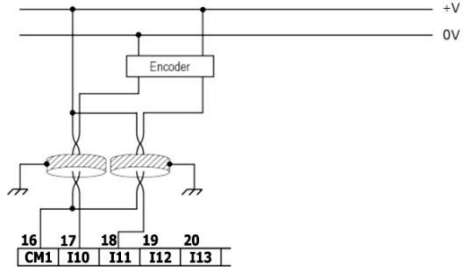

**NOTE** Use sink input wiring to connect a sourcing (pnp) device.  
Use source input wiring to connect a sinking (npn) device.

**Wiring the Analog Inputs**

Both inputs share the common point CM2.

- NOTE**
- Each input offers two modes: voltage or current. You can set each input independently. The mode is determined both by wiring and by the hardware configuration within the software application.
  - Voltage and current modes use distinct points. Connect only the point associated with the selected mode; leave the other point unconnected.

Voltage

Differential

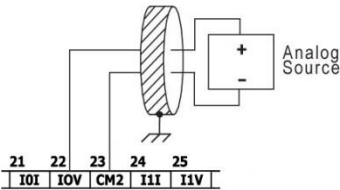

Single-ended

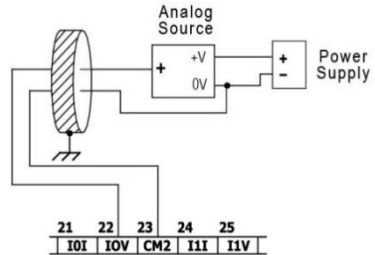

Current

2-wire

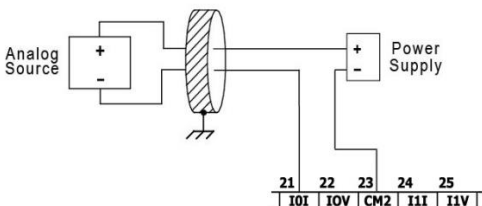

3-wire

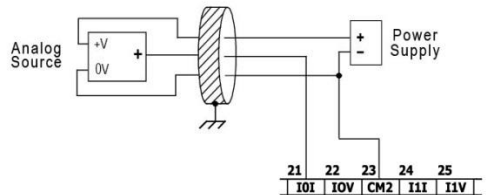

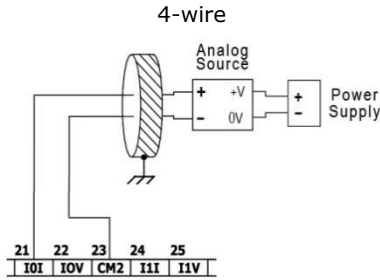

## Wiring the Temperature Inputs

**NOTE** Each input offers three modes: thermocouple, mV or RTD. You can set each input independently. The mode is determined both by wiring and by the hardware configuration within the software application.

In order to ensure that the temperature inputs operate correctly, connect the points RTn+ and RTn- of unused temperature inputs together. Note that 'n' designates input number).

## Thermocouple and mV

Thermocouple

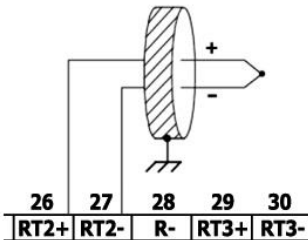

mV

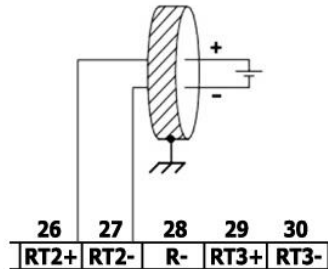

## About Thermocouple Isolation

Although the temperature inputs are isolated from the bus and the controller's power-supply port, they are neither isolated from each other nor from the analog inputs. Therefore, temperature inputs isolation may be bypassed when using an exposed-junction (non-isolated) thermocouple in conjunction with analog inputs or another exposed-junction thermocouple, which can lead to flow of unwanted currents through the thermocouple wires that might interfere with thermocouple voltage reading.

In order to maintain temperature inputs isolation when using one or more of the analog inputs or when using more than one thermocouple, either:

- Use isolated-junction thermocouples, or, if you are not using the analog inputs, you may use up to one exposed-junction thermocouple;
- Electrically isolate exposed-junction thermocouples from other electrically-conductive parts of the system.

## RTD

- NOTE**
- When connecting 3- or 4-wire RTDs, make sure to use conductors of the same type, width, and length for all RTD wires, otherwise the accuracy will degrade.
  - When connecting 4-wire RTDs, use 3-wire cable and leave the unused wire unconnected and of minimal length.

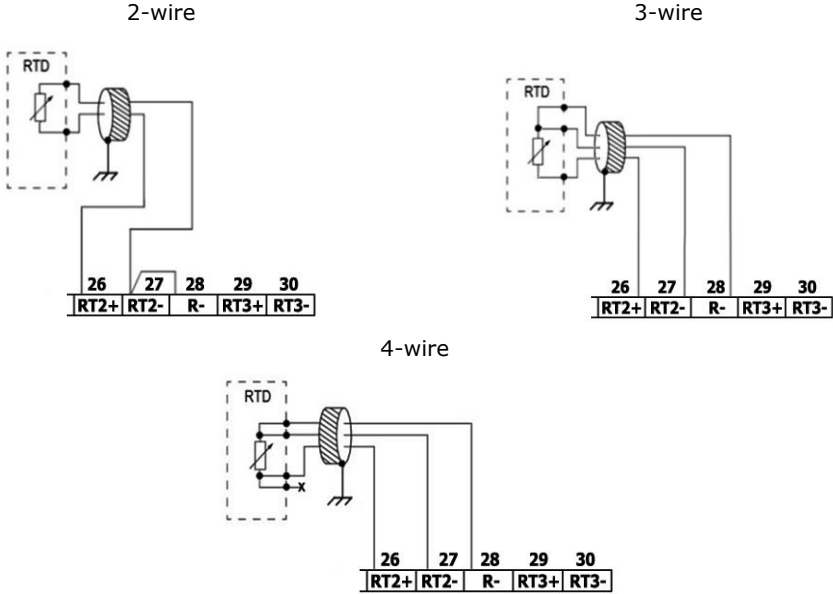

## Wiring the Relay Outputs (USC-xx-RA28)

- ⚠** To avoid risk of fire or property damage, always use a limited current source or connect a current limiting device in series with the relay contacts

The relay outputs are arranged in two isolated groups:

O0-O3 share the common return CM3.

O4-O7 share the common return CM4.

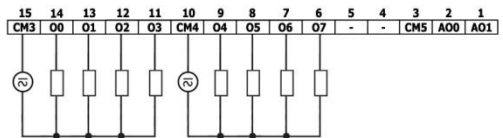

### Increasing Contact Life Span

To increase the life span of the relay contacts and protect the controller from potential damage by reverse EMF, connect:

- a clamping diode in parallel with each inductive DC load,
- a RC snubber circuit in parallel with each inductive AC load

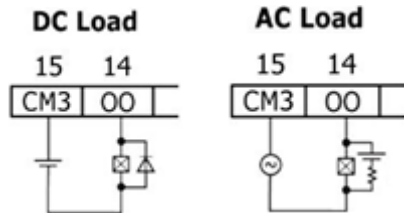

## Wiring the Source Transistor Outputs (USC-xx-TA30)

### Output's power supply

The use of any of the outputs requires an external 24VDC power supply as shown in the accompanying figure.

### Outputs

Connect the +VO and 0VO terminals as shown in the figure.

O0-O9 share common return 0VO.

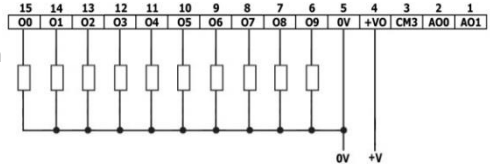

## Wiring the Analog Outputs

- NOTE**
- The outputs are not isolated.
  - Each output offers two modes: voltage or current. You can set each output independently.
  - The mode is determined by the hardware configuration within the software application.
  - Note that if, for example, you wire the output to current input, you must also set it to current in the software application.

CM5 is internally connected to the 0V point. To minimize EMI pickup by analog signals' wiring, do not externally connect CM5 to the system 0V.



- Do not use point CM5 for any purpose other than connecting the analog output load. Using it for any other purpose may damage the controller.

### Voltage / Current

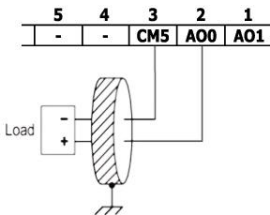

## Installing Uni-I/O™ & Uni-COM™ Modules

Refer to the Installation Guides provided with these modules.



- Turn off system power before connecting or disconnecting any modules or devices.
- Use proper precautions to prevent Electro-Static Discharge (ESD).

## Uninstalling the Controller

1. Disconnect the power supply.
2. Remove all wiring and disconnect any installed devices according to the device's installation guide.
3. Unscrew and remove the mounting brackets, taking care to support the device to prevent it from falling during this procedure.

The information in this document reflects products at the date of printing. Unitronics reserves the right, subject to all applicable laws, at any time, at its sole discretion, and without notice, to discontinue or change the features, designs, materials and other specifications of its products, and to either permanently or temporarily withdraw any of the forgoing from the market.

All information in this document is provided "as is" without warranty of any kind, either expressed or implied, including but not limited to any implied warranties of merchantability, fitness for a particular purpose, or non-infringement. Unitronics assumes no responsibility for errors or omissions in the information presented in this document. In no event shall Unitronics be liable for any special, incidental, indirect or consequential damages of any kind, or any damages whatsoever arising out of or in connection with the use or performance of this information.

The tradenames, trademarks, logos and service marks presented in this document, including their design, are the property of Unitronics (1989) (R"G) Ltd. or other third parties and you are not permitted to use them without the prior written consent of Unitronics or such third party as may own them

DOC32002-B3 REV. B00 12/20